

No	a*b	X
1	596x398	2
2	596x300	1
3	1101x451	1
4	1102x472	1
5	376x450	2
6	284x450	1
7	584x451	1
8	1068x101	2
9	584x451	1
10	568x451	1
11	568x451	1
12	596x397	2
13	297x297	1

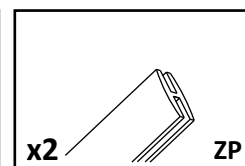

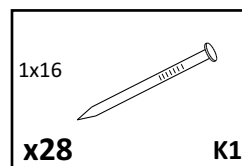
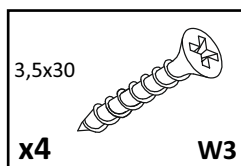
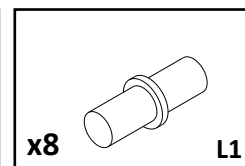
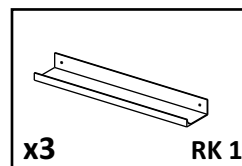
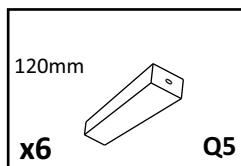
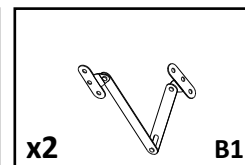
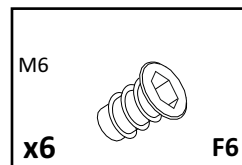
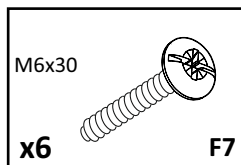
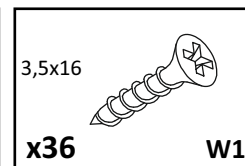
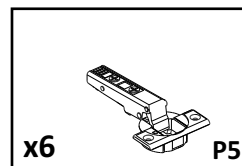
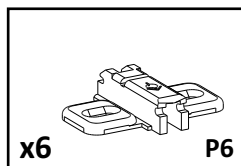
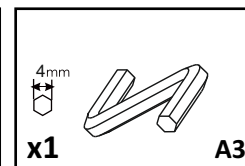
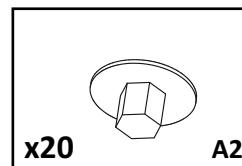
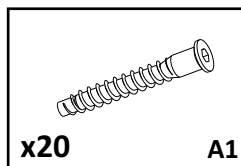
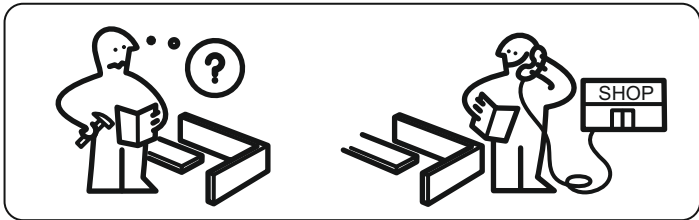
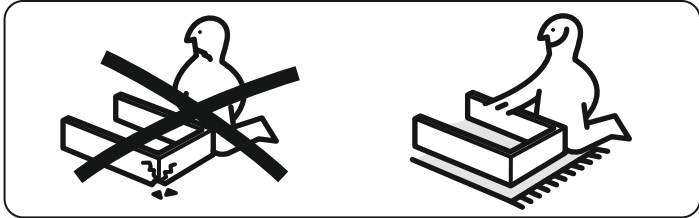
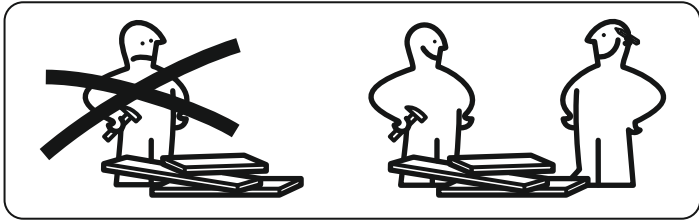
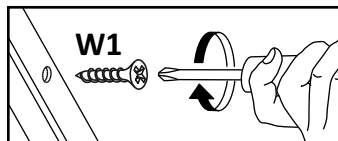
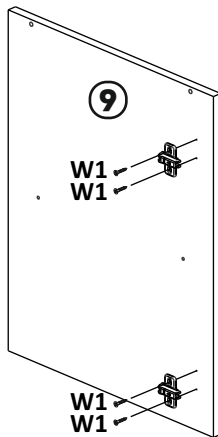
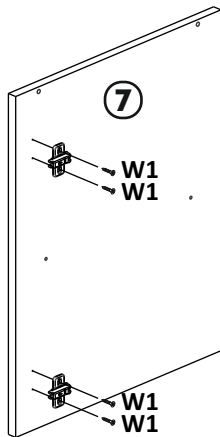
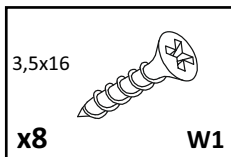
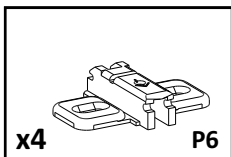
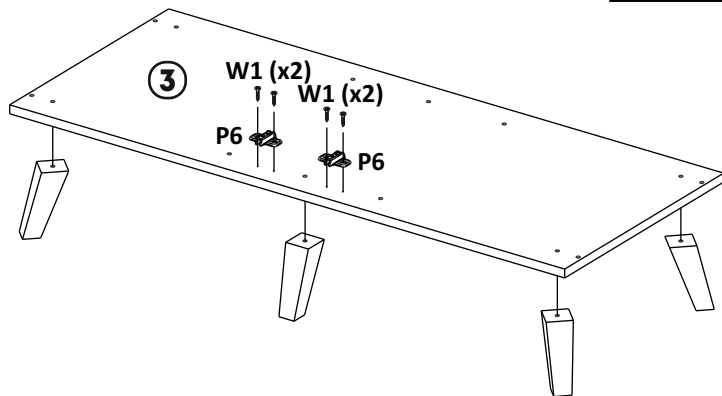
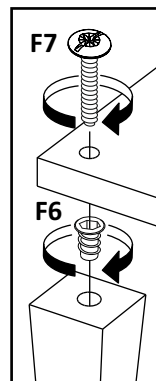
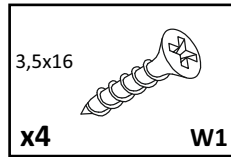
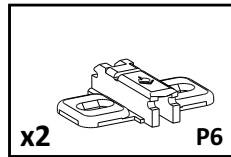

1**2**

3

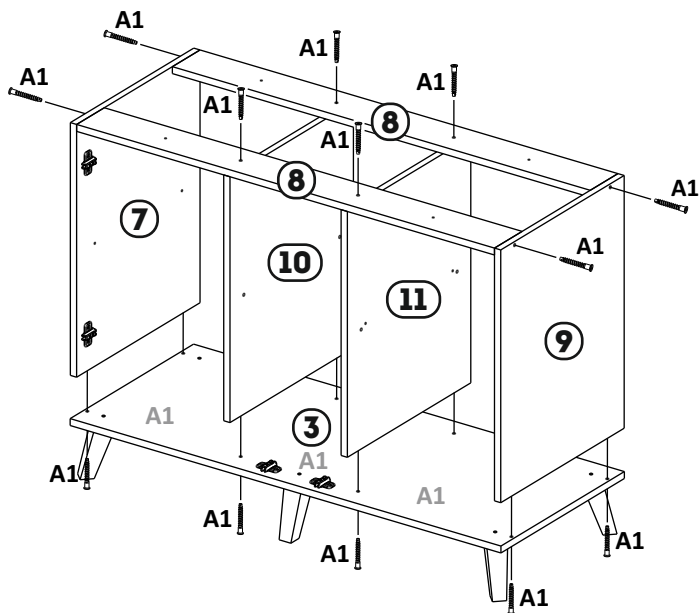
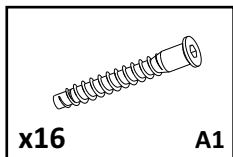

4

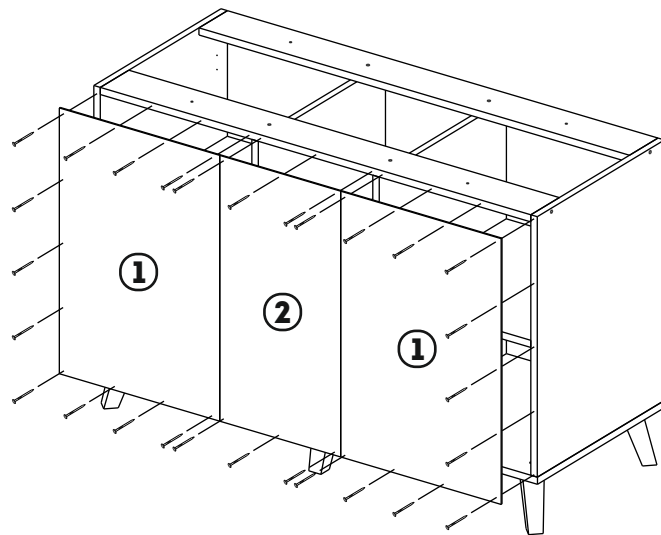
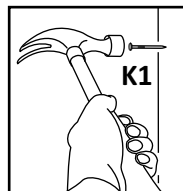
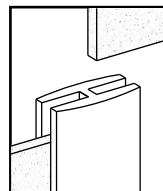
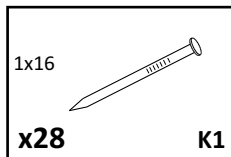

5

3,5x30

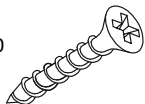

x4

W3

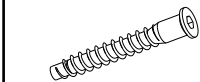

x4

A1



x4

A2

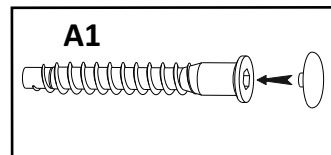
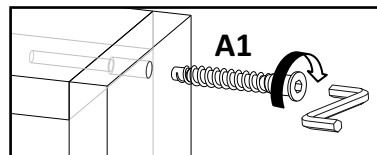
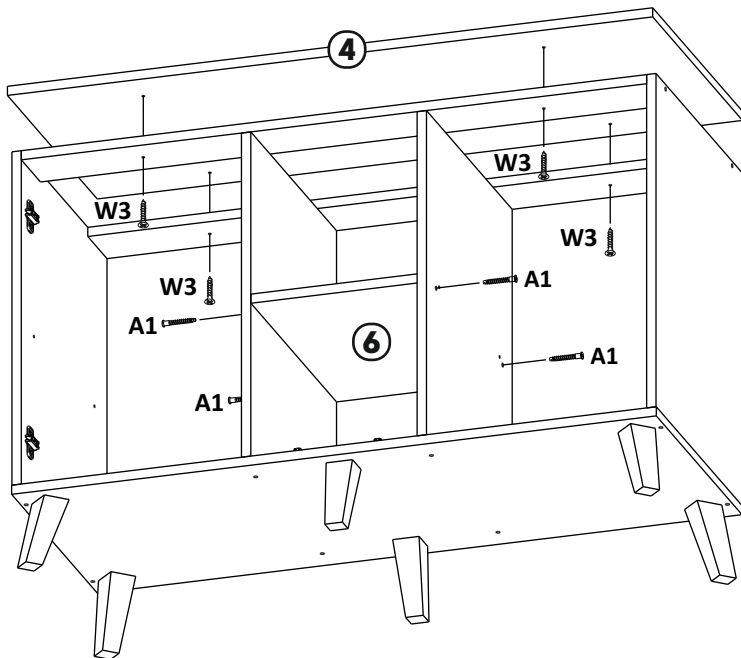

6

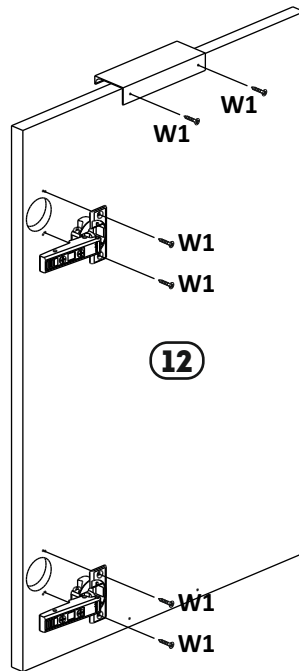
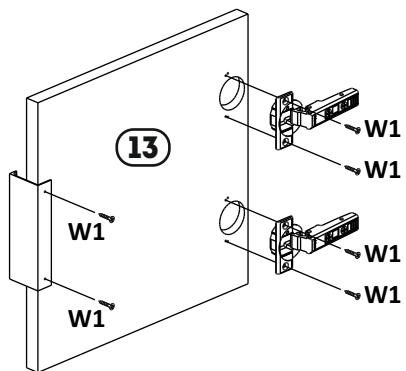
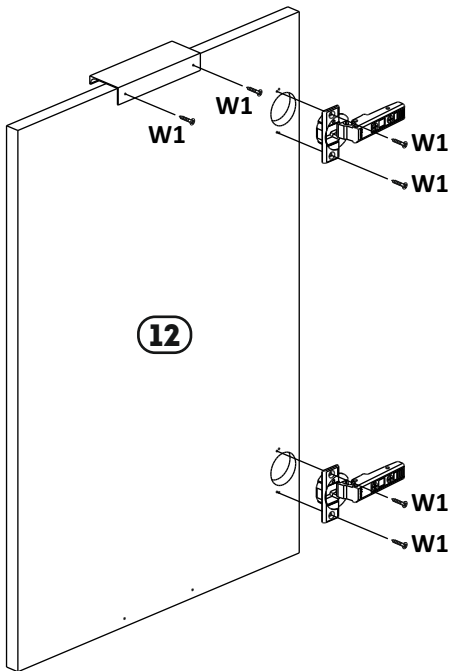
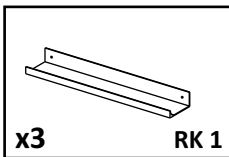
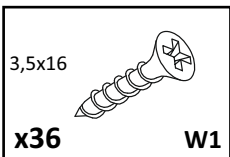
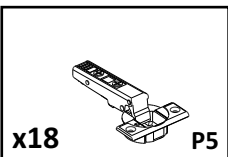

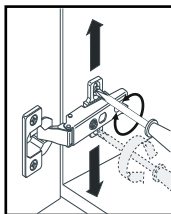
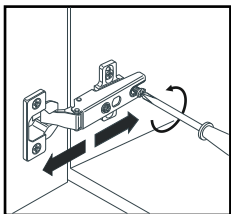
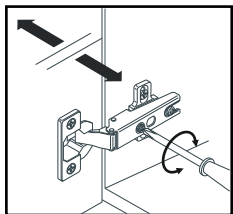
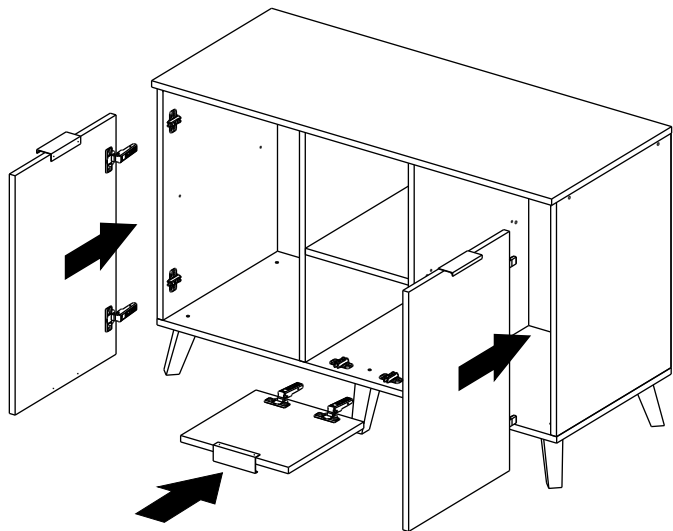
7**8**